

MIKRO KOMPLETI

1

LANČANI PRIJENOS

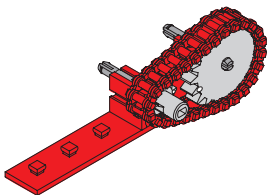

2

ZUPČANI PRIJENOS

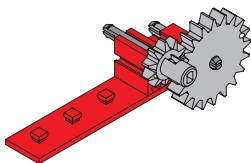

3

REMENSKI PRIJENOS

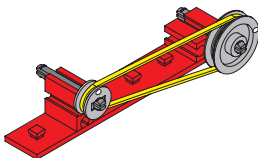

1

LANČANI PRIJENOS

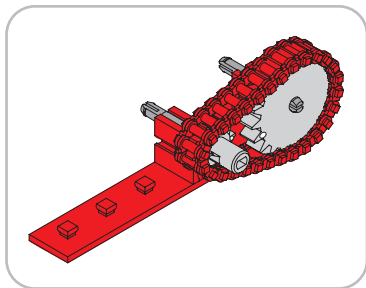
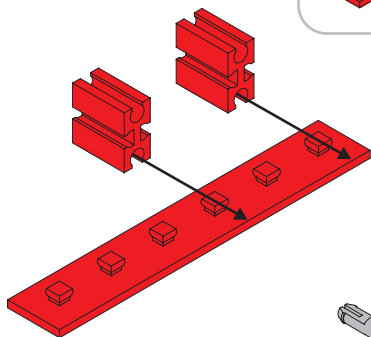
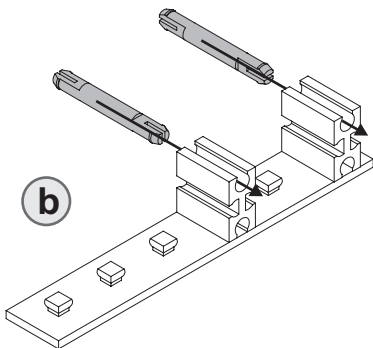
**a****b**

spajanje karika lanca (28)

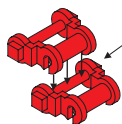

c

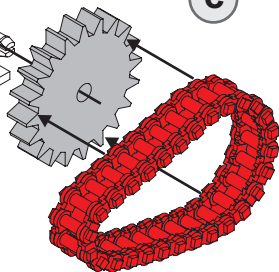

d

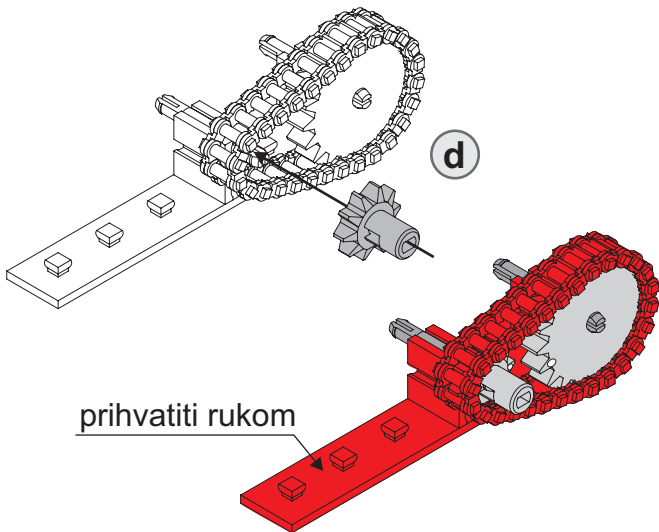

prihvatiti rukom

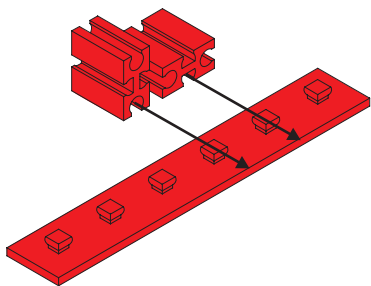
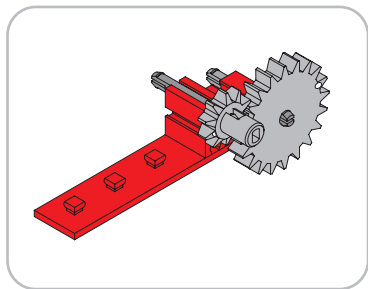
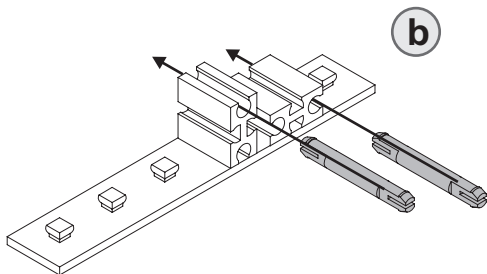
2**ZUPČANI PRIJENOS****a****b**

C

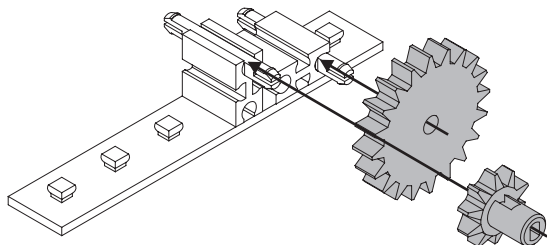

prihvatiti rukom

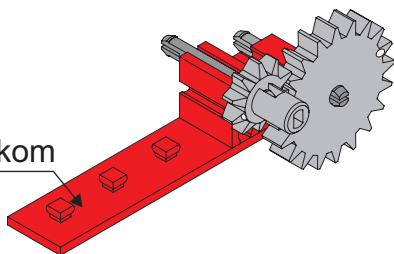

3**REMENSKI PRIJENOS**